

Anritsu envision : ensure

Universal Wireless Test Set

MT8870A

TRX Test Module

MU887000A/MU887001A 10 MHz to 3.8 GHz, 10 MHz to 6 GHz (Option)

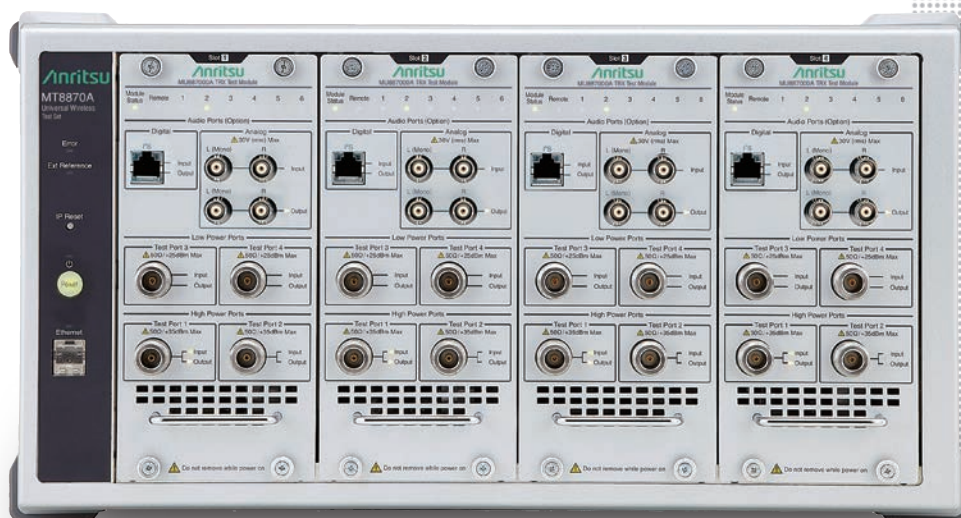

Designed to Maximise Production Throughput

For Production Lines for Smartphones and Communications Modules

The remarkable success of smartphones and tablets is driving demand for faster inspection speeds on smartphone and communication module production lines and this market trend is expected to continue. Coupled with this, wireless communication standards are continuing to evolve and develop, leading to a growing range of specifications.

In these circumstances, terminal and module makers are looking to increase line efficiency while assuring smooth and flexible support for the various new standards.

With support for up to four test modules, the Universal Wireless Test Set MT8870A is the ideal cost-effective solution for high-efficiency inspection lines.



Four High-performance Test Modules in One Chassis

To enhance efficiency and reduce initial costs, up to four TRX test modules can be installed in each MT8870A. This modular system brings with it the flexibility to adapt to changes in volume and to shifts and developments in wireless standards.

Up to
4
Modules

Up to four test modules
can be installed
in one chassis



MT8870A



Flexible Product Design for Parallel Testing of Multiple Wireless Standards



Up to
4
Measurement
Types

Four standards can be measured at once using four test modules in one chassis



M₁, M₂, M₃, M₄

Simultaneous Measurement of Multiple Communication Standards

Smartphones and tablets with various wireless chipsets and antennas can all be tested with one MT8870A. Because each installed test module can be controlled independently, multiple wireless tests can be run simultaneously.

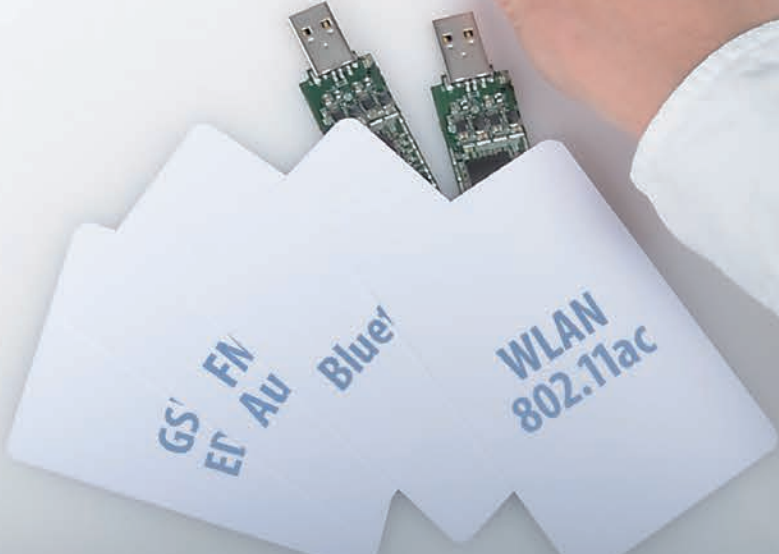

Universal Wireless Test Set MT8870A Features

Simultaneous Control of Four Test Modules

Installing four independent test modules in the MT8870A supports simultaneous measurement of four separate wireless devices. A unique IP address can be allocated to each slot and each test module supports remote control by Ethernet or optional GPIB connections.

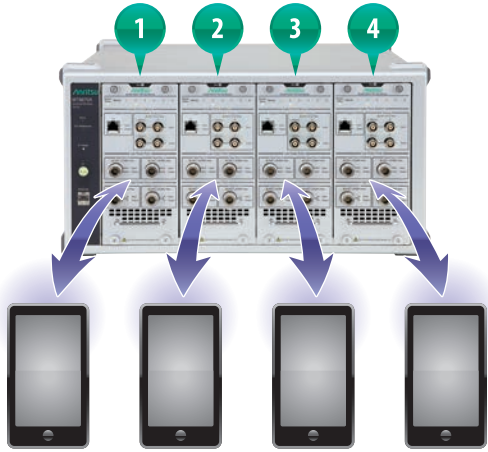

Four Simultaneous Measurements

Today's smartphones and tablets often support multiple wireless chipsets that all need to be tested and approved in the shortest possible time. Configuring an MT8870A with four test modules enables simultaneous testing of all wireless standards and greatly increases throughput efficiency.

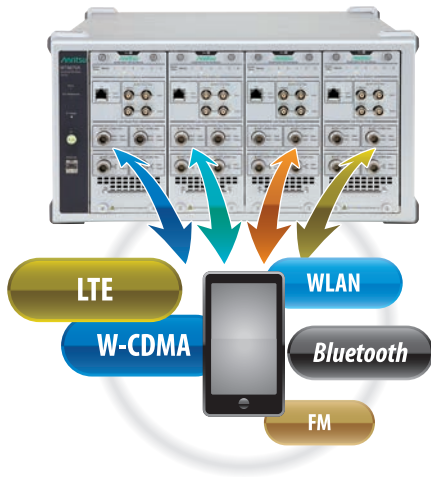

50% to 75% Smaller Instrument Footprint

Instead of four separate test stations each requiring setup, the all-in-one, high-performance MT8870A main frame with up to four test modules saves both production line space and setup time.

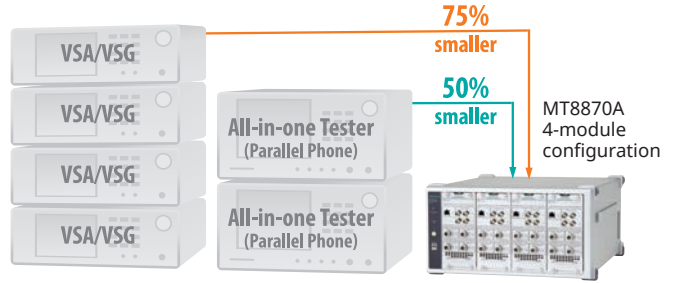

Compared to conventional Anritsu products	All-in-one Tester (Parallelphone)	VSA/VSG
MT8870A 4-module configuration	50% smaller	75% smaller

40%* Reduction in Infrastructure Costs with Four Installed Test Modules

With four TRX test modules in one MT8870A main frame, the shared components cut capital costs by about 40%.

*: Typical 4-module configuration compared to single module design

Universal Wireless Test Set MT8870A Panel Layout

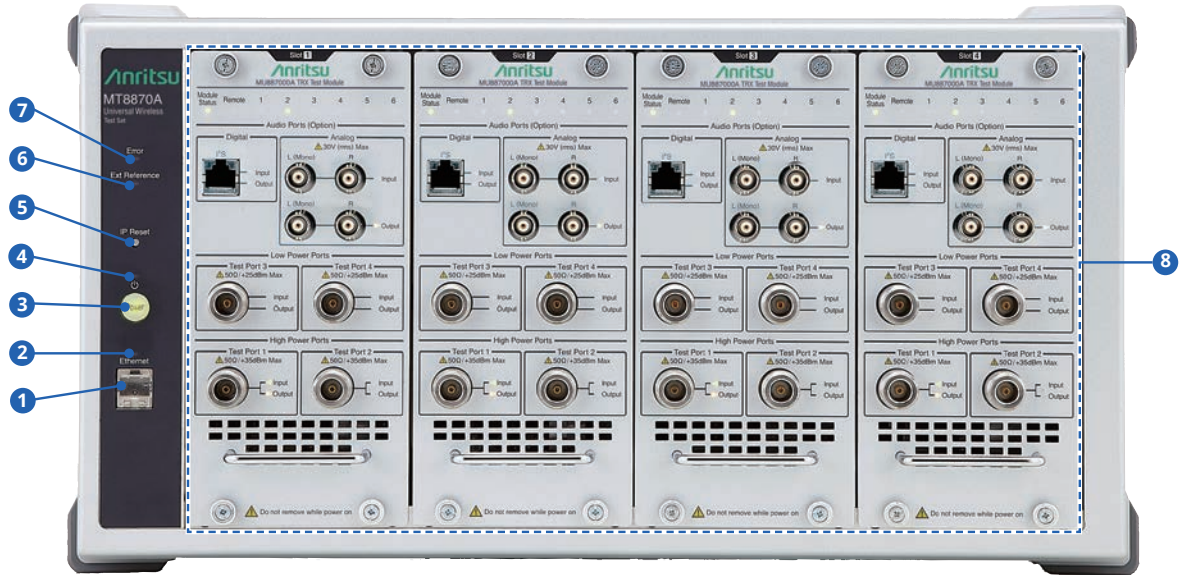

Front panel

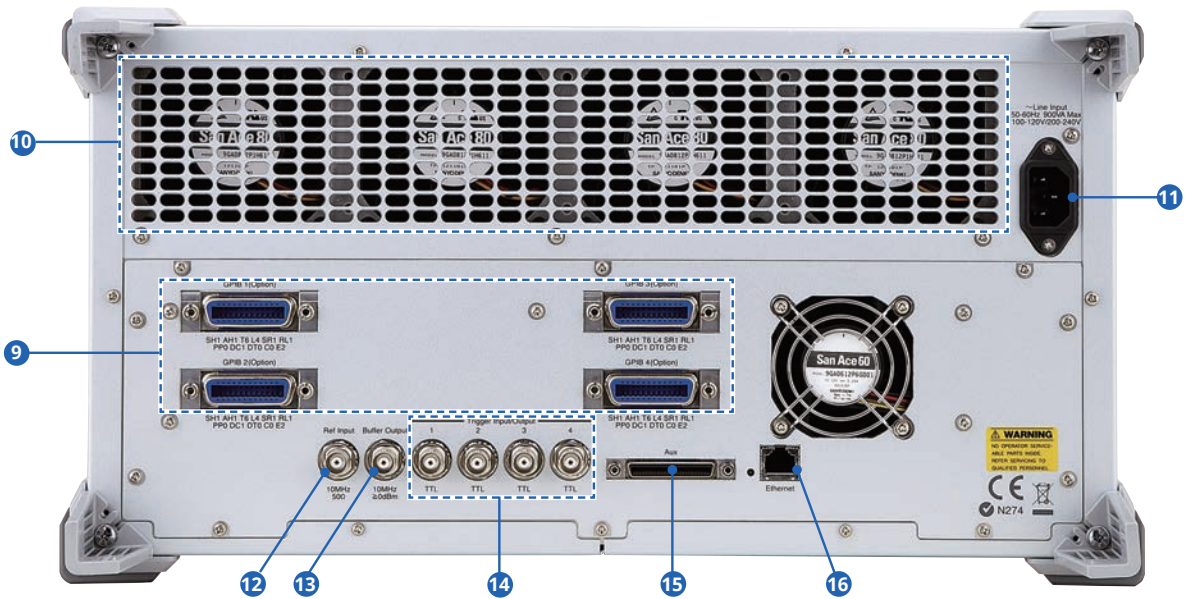

Rear panel

- | | |
|---|--|
| 1 Ethernet Connector | 9 GPIB Connector (option) |
| 2 Access Lamp | 10 Cooling Fan |
| 3 Power Switch | 11 Power Cord Connector |
| 4 Standby Lamp | 12 External Reference Signal Input (ref input) |
| 5 IP Address Reset Button (IP reset) | 13 Reference Signal Output (buffer output) |
| 6 External Reference Signal Lamp (ext. reference) | 14 Trigger Input/Output Connector |
| 7 Error Lamp | 15 AUX Connector |
| 8 Slot 1 to 4 | 16 Ethernet Connector |

High Performance Coupled with Flexibility and Expandability



MU887000A / 01A



MU887000A
TRX Test Module



MU887000A
TRX Test Module
with Option 002 (Audio)



MU887001A
TRX Test Module



MU887001A
TRX Test Module
with Option 002 (Audio)

Future-proof Inspection Lines

Mobile terminal manufacturers require not only production line efficiency but also the flexibility to adapt to changes in wireless standards. The MT8870A is the ideal instrument to meet these needs.



1 Built-in Signal Generator and Signal Analyzer in Each Test Module

The TRX Test Module MU887000A/01A (MU88700xA) has been developed for communication terminal device inspection lines. Each installed test module has an independent high-performance signal generator and signal analyzer.



2 160 MHz Wide Bandwidth

To support the WLAN 802.11ac (Wave 2) and (extended) LTE-Advanced wireless standards requiring bandwidths of 100 MHz or more, the MU88700xA incorporates a signal generator and signal analyzer with a bandwidth of 160 MHz.



3 Wide Frequency Range from 10 MHz to 6 GHz (option)

The MU88700xA signal generator and signal analyzer cover a frequency range from 10 MHz to 3.8 GHz (extended to 6 GHz as option), assuring flexible support for new wireless standards.

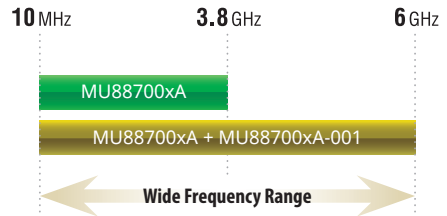

4 Each Test Module Supports Multiple Wireless Standards

One MU88700xA supports multiple wireless communication standards.

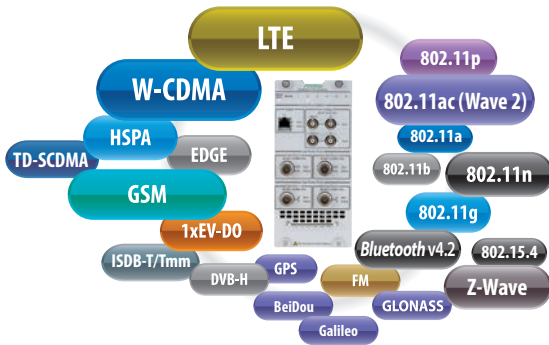

Wireless Standards	Specifications
W-CDMA/HSDPA	3GPP TS 34.121-1 3GPP TS 25.141
GSM/EDGE	3GPP TS 51.010-1
LTE	3GPP TS 36.521-1 3GPP TS 36.141
CDMA2000	3GPP2 TSG-C.S0011-C
1xEV-DO	3GPP2 TSG-C.S0033-B
TD-SCDMA	3GPP TS 34.122
WLAN	IEEE 802.11a/b/g/n/p/ac (Wave 2)
Bluetooth	Basic Rate/EDR/Bluetooth low energy (Bluetooth v4.2)
ZigBee	IEEE 802.15.4
Z-Wave	ITU-T G.9959
FM	RDS (IEC 62106 Edition 2.0)
GPS	GPS standard Positioning Service Signal
Galileo	European GNSS (Galileo) Open Service Signal In Space Interface Control Document
GLONASS	GLONASS ICD Navigational radiosignal In bands L1, L2
BeiDou	BeiDou Navigation Satellite System Signal In Space Interface Control Document Open Service Signal (Version 2.0)
DVB-H	ETSI EN300 744
ISDB-T/Tmm	ARIB STD-B31/B46

Each standard is supported easily using a cost-effective licensing scheme

Licenses are obtained by adding TX measurement software packages and waveform files.

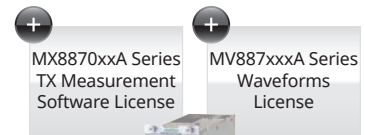

MU887000A/MU887001A TRX Test Module

TRX Test Module MU88700A/01A Features

Integration with Leading-edge High-speed Measurement Methods

Times for manufacturing and testing mobile terminals have been slashed using leading-edge hardware architecture and parallel measurement technology. Additionally, multiple items for batch measurement processing can be freely selected for any number of repeat measurements.

Batch measurement of selected items greatly simplifies and speeds up key tests.

Non-signalling Measurement Support

The MT8870A performs measurements in a non-signalling environment. As shown in the figure below, alleviating the need to establish direct communication with the DUT brings considerable savings in both time and manufacturing costs.

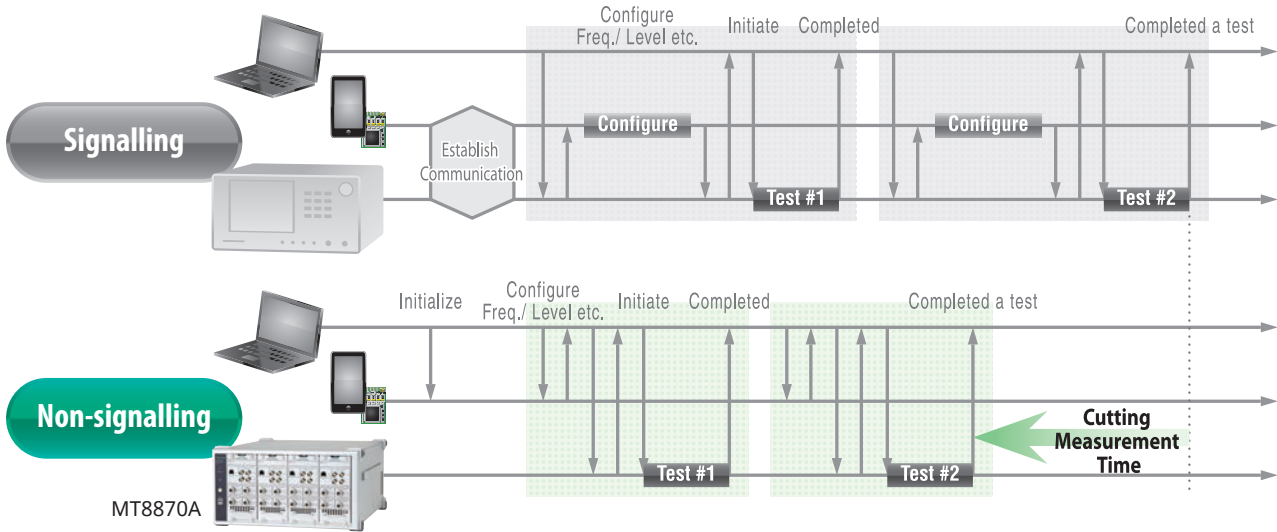

Sequence Measurement (Mobile Communication Terminals)

- For mobile terminals supporting sequence measurements (list mode), TRX tests are performed in accordance with a sequence table (list) where measurement conditions are recorded while changing the test conditions.
- Since each measurement is executed at high speed in accordance with a predetermined sequence without using remote control commands, line tact times are greatly reduced, increasing line throughput and efficiency.

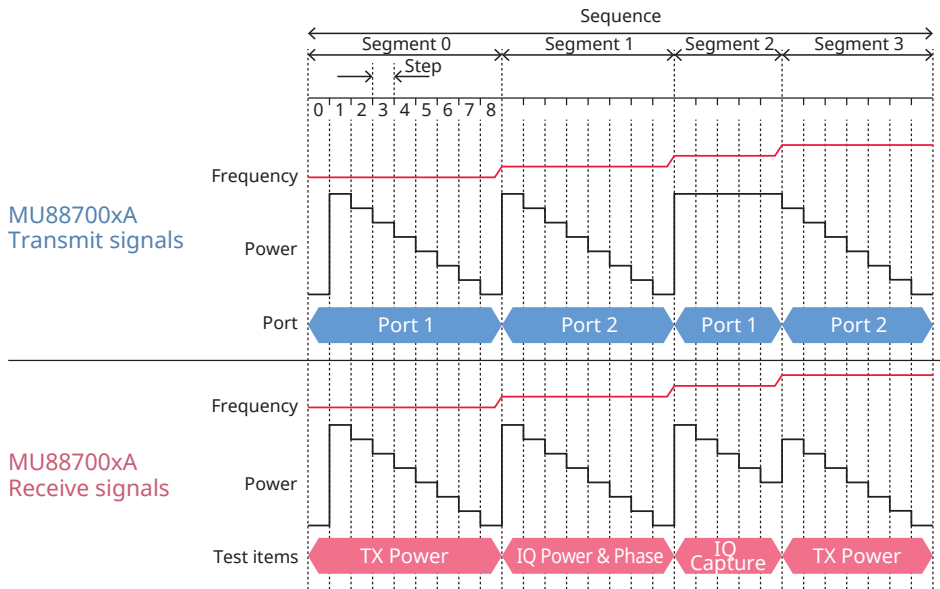

TRX Test Module MU887000A/01A Features

Four Test Ports per Module

Each MU887000A has two duplex and two half-duplex RF connectors.

The duplex ports (Test port 1 and 2) incorporate dividers at the front end to support simultaneous tests in both TX and RX directions when testing typical wireless standards.

The half-duplex ports (Test port 3 and 4) incorporate switches at the front end to switch between each test port when used either for TX or RX tests. These half-duplex ports have higher sensitivity than the full-duplex ports and are ideal for low-level wireless signals.

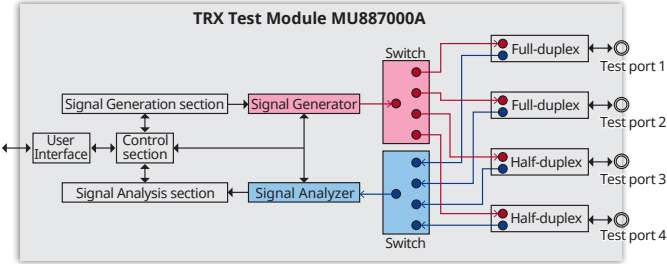

The MU887001A has four duplex RF connectors.

Each MU887001A has four duplex RF connectors so that the test module can connect four mobile terminals at once to test them by high speed switching with the internal RF switches. Also the isolation performance between each test port is better than MU887000A.

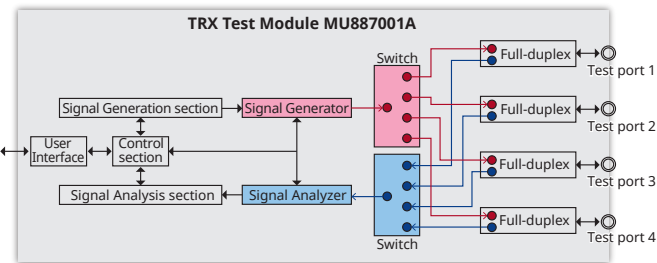

The four test ports can be used for level calibration because they have high level accuracy over a wide frequency range from 10 MHz to 6 GHz (option). Internal switches can switch the TRX ports between input and output. Normally, simultaneous coupling measurements of multiple antennas require troublesome calibration corrections when using the required external dividers and external switches. With four test ports each incorporating the internal switch level deviation, the MU88700xA supports high level accuracy measurements over a wide frequency range.

Test Port and Wireless Technology

MU887000A

	Test port 1 and 2	Test port 3 and 4
Name	High power port	Low power port
Connector	N (female)	N (female)
Type (Configuration)	Duplex (divider)	Half-duplex (switch)
Outline	Support simultaneous use of VSG and VSA required for measuring mobile terminal standards	Do not support simultaneous use of VSA and VSG each of which must be used separately High accuracy supports measurement of low-level signals
Wireless Standards and Recommended Port	LTE FDD/TDD, W-CDMA, GSM/EDGE, CDMA2000/1xEV-DO, TD-SCDMA, WLAN 802.11a/b/g/n/p/ac*, Bluetooth*, IEEE 802.15.4*, Z-Wave, FM/RDS, GPS, Galileo, GLONASS, BeiDou, DVB-T, ISDB-T/Tmm	Cellular Diversity, WLAN 802.11a/b/g/n/p/ac, Bluetooth, IEEE 802.15.4, Z-Wave, FM/RDS, GPS, Galileo, GLONASS, BeiDou, DVB-T, ISDB-T/Tmm

MU887001A

	Test port 1 to 4
Name	High power port
Connector	N (female)
Type (Configuration)	Duplex (divider)
Outline	Support simultaneous use of VSG and VSA required for measuring mobile terminal standards
Wireless Standards and Recommended Port	LTE FDD/TDD, W-CDMA, GSM/EDGE, CDMA2000/1xEV-DO, TD-SCDMA, WLAN 802.11a/b/g/n/p/ac, Bluetooth, IEEE 802.15.4, Z-Wave, FM/RDS, GPS, Galileo, GLONASS, BeiDou, DVB-T, ISDB-T/Tmm

*: Since test ports 1 and 2 have higher input levels than ports 3 and 4, use ports 3 and 4 when the MU88700xA input level is low.

TRX Test Module MU887000A/01A Features

Built-in Audio Analyzer/Audio Generator

Installing the Audio Measurement Hardware MU88700xA-002 in the MU88700xA supports a built-in audio analyzer and audio generator.

The MU88700xA-002 supports both analog and digital audio. The stereo and monaural analog audio inputs and outputs of a communications device can be measured using the four BNC connectors (input and output for both left and right channels). Additionally, digital audio communications modules without analog audio inputs and outputs are supported without needing an AD/DC converter using the RJ-45 connector on the MU88700xA to measure digital audio signals using the standard inter-IC Sound (I2S) format.

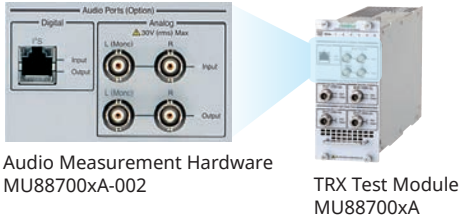

The MU88700xA-002 solution saves spaces and cuts costs by combining RF and audio measurements into one unit, eliminating the need for separate production lines for RF measurements and audio measurements.

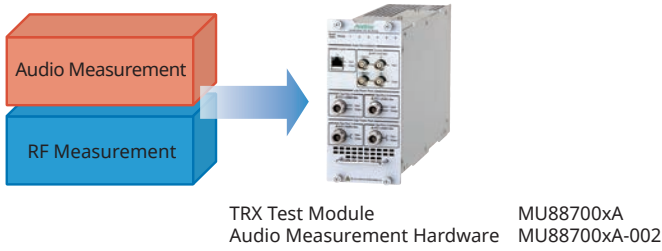

✱: The audio analyzer and audio generator functions cannot be used simultaneously.

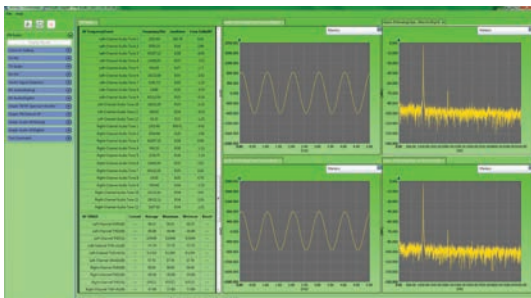

CombiView Audio Measurement Screen

Ease of Configuration

Line capacity can change from week to week or month to month, depending on customers' needs and the specifications of the device under test. The number of test modules installed*1 in the MT8870A can be tailored to meet changes in line test stations and items, keeping the line efficiency high without needing major configuration changes to the line and stations.



✱1: Test modules cannot be hot-swapped with the power on.

TRX Test Module MU887000A/01A Features

One License for All Test Modules

Versatile Software Licenses

TX and RX measurement capabilities are enabled through licenses that can be purchased as required. Each license enables the associated capabilities on all installed test modules and represents excellent value for money in comparison to traditional, non-modular test systems.

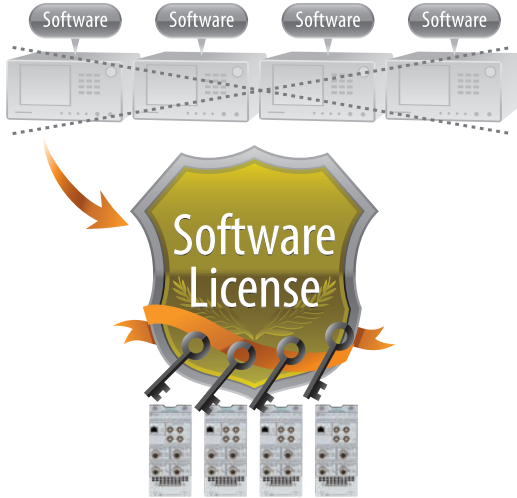

Software for MU88700xA TRX Test Module

MX8870xxA Series Measurement Software

Model	Description
MX887010A	Cellular Standards Sequence Measurement
MX887011A	W-CDMA/HSPA Uplink TX Measurement
MX887012A	GSM/EDGE Uplink TX Measurement
MX887013A	LTE FDD Uplink TX Measurement
MX887014A	LTE TDD Uplink TX Measurement
MX887015A	CDMA2000 Reverse Link TX Measurement
MX887016A	1xEV-DO Reverse Link TX Measurement
MX887017A	TD-SCDMA Uplink TX Measurement
MX887021A	W-CDMA/HSPA Downlink TX Measurement
MX887023A	LTE FDD Downlink TX Measurement
MX887030A	WLAN 802.11b/g/a/n TX Measurement
MX887031A	WLAN 802.11ac TX Measurement
MX887032A	WLAN 802.11p TX Measurement
MX887040A	Bluetooth TX Measurement
MX887040A-001	DLE TX Measurement
MX887050A	Short Range Wireless Average Power and Frequency Measurement
MX887060A	IEEE 802.15.4 TX Measurement
MX887061A	Z-Wave TX Measurement
MX887070A	FM/Audio TRX Measurement
MX887090A	Multi-DUT Measurement Scheduler

MV887xxxA Series Waveforms

Model	Description
MV887011A	W-CDMA/HSPA Downlink Waveforms
MV887012A	GSM/EDGE Downlink Waveforms
MV887013A	LTE FDD Downlink Waveforms
MV887014A	LTE TDD Downlink Waveforms
MV887015A	CDMA2000 Forward Link Waveforms
MV887016A	1xEV-DO Forward Link Waveforms
MV887017A	TD-SCDMA Downlink Waveforms
MV887021A	W-CDMA/HSPA Uplink Waveforms
MV887023A	LTE FDD Uplink Waveforms
MV887030A	WLAN 802.11b/g/a/n Waveforms
MV887031A	WLAN 802.11ac Waveforms
MV887032A	WLAN 802.11p Waveforms
MV887040A	Bluetooth Waveforms
MV887040A-001	DLE Waveforms
MV887060A	IEEE 802.15.4 Waveforms
MV887061A	Z-Wave Waveforms
MV887070A	FM RDS Waveforms
MV887100A	GPS Waveforms
MV887101A	Galileo Waveforms
MV887102A	GLONASS Waveforms
MV887103A	BeiDou Waveforms
MV887110A	DVB-H Waveforms
MV887111A	ISDB-T Waveforms
MV887112A	ISDB-Tmm Waveforms

TRX Test Module MU887000A/01A Panel Layout

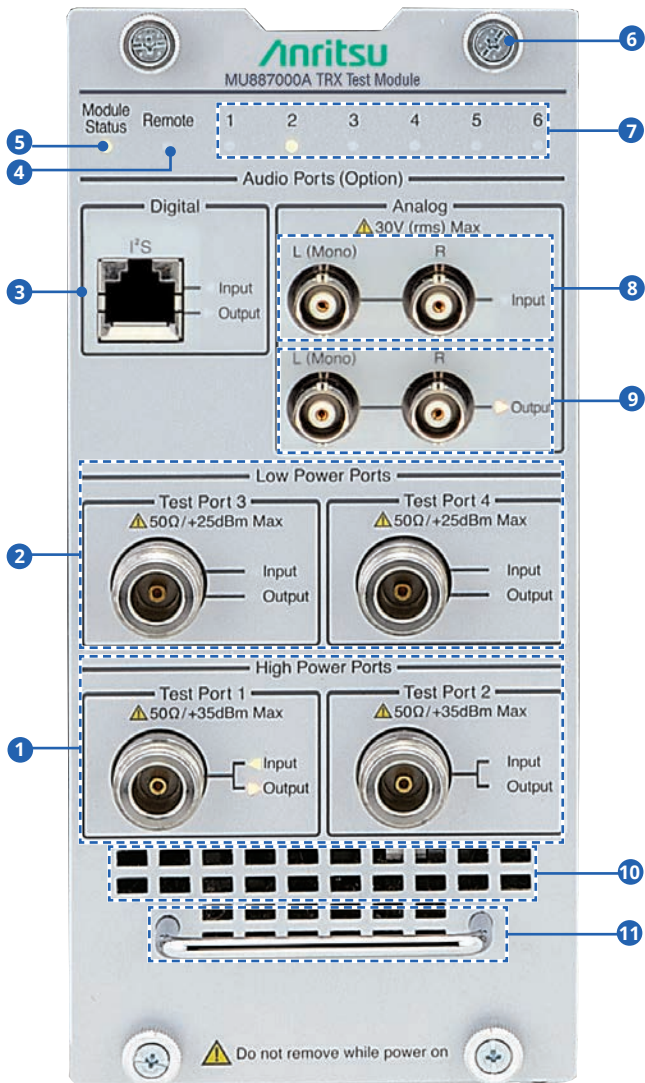

MU887000A

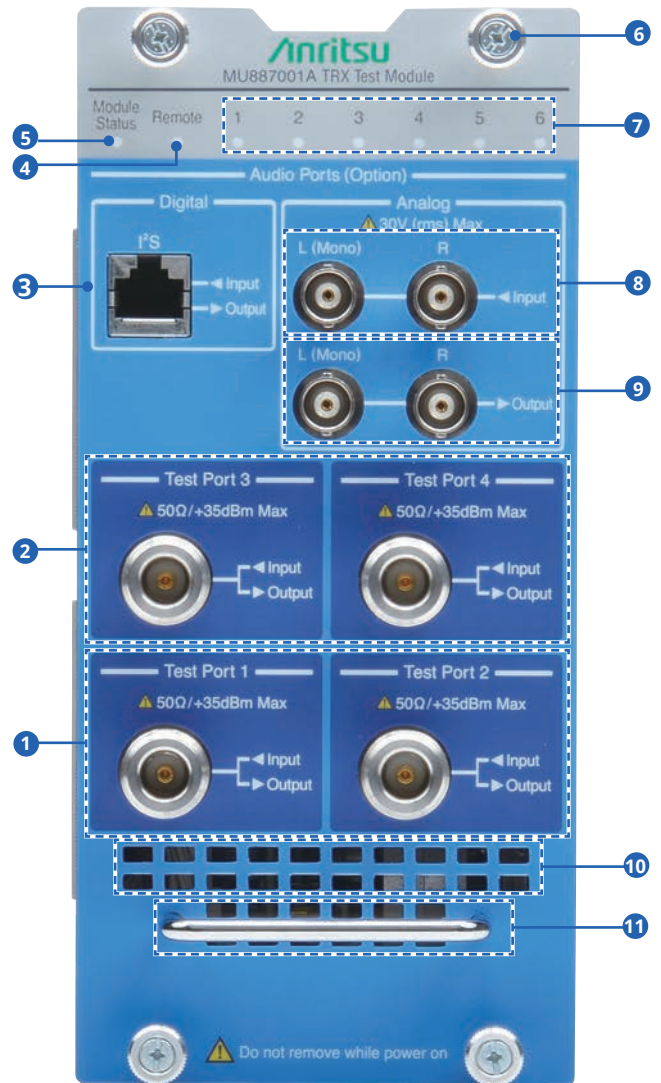

MU887001A

- ❶ Test Port 1, 2
- ❷ Test Port 3, 4
- ❸ Digital Audio Input/Output (option)
- ❹ Remote Lamp (remote)
- ❺ Status Lamp (module status)
- ❻ Mounting screws
- ❼ Status Lamp (1 to 6)
- ❽ Analog Audio Input (option)
- ❾ Analog Audio Output (option)
- ❿ Vent
- ⓫ Handle

Universal Wireless Test Set MT8870A Applications

Manufacturing Smartphones

LTE Smartphone Measurement

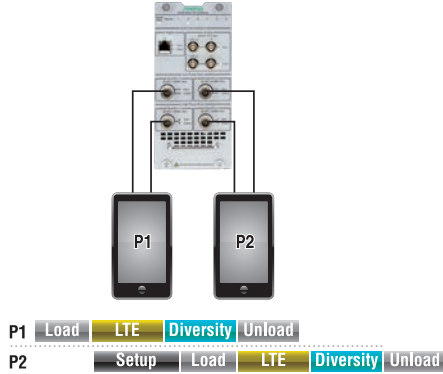

Two smartphones can be measured alternately using one TRX Test Module. While one smartphone is being measured, the second is being prepared for measurement. When measurement of the first phone is completed, measurement of the second phone starts and the phone measured first can be replaced with a third phone to start measurement preparation.

This continuing sequence greatly reduces wasted time at connection and measurement to improve line throughput.

Recommended Configuration

Model	Description	Qty.
MT8870A	Universal Wireless Test Set	1
MU88700xA	TRX Test Module	1
MX887013A	LTE FDD Uplink TX Measurement	1
MV887013A	LTE FDD Downlink Waveforms	1

Smartphone Measurement

(Simultaneous Measurement of Multiple Wireless Technologies)

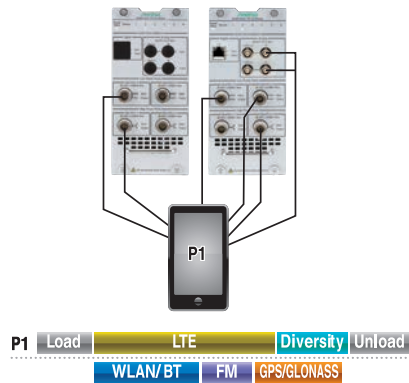

Two TRX Test Modules can be used to measure multiple wireless technologies in one smartphone.

The multiple antennas for the various wireless technologies in the smartphone are connected all at one time to execute measurements in parallel, greatly reducing the problems of moving smartphones between test stations and re-booting time for smartphone.

Recommended Configuration

Model	Description	Qty.
MT8870A	Universal Wireless Test Set	1
MU88700xA	TRX Test Module	2
MU88700xA-001	6 GHz Frequency Extension	2
MU88700xA-002	Audio Measurement Hardware	1
MX887013A	LTE FDD Uplink TX Measurement	1
MX887030A	WLAN 802.11b/g/a/n TX Measurement	1
MX887031A	WLAN 802.11ac TX Measurement	1
MX887040A	Bluetooth TX Measurement	1
MX887040A-001	DLE TX Measurement	1
MX887070A	FM/Audio TRX Measurement	1
MV887013A	LTE FDD Downlink Waveforms	1
MV887030A	WLAN 802.11b/g/a/n Waveforms	1
MV887031A	WLAN 802.11ac Waveforms	1
MV887040A	Bluetooth Waveforms	1
MV887040A-001	DLE Waveforms	1
MV887070A	FM RDS Waveforms	1
MV887100A	GPS Waveforms	1
MV887102A	GLONASS Waveforms	1
MV887103A	BeiDou Waveforms	1

Universal Wireless Test Set MT8870A Applications

Manufacturing Communication Modules

Combo Module Measurement

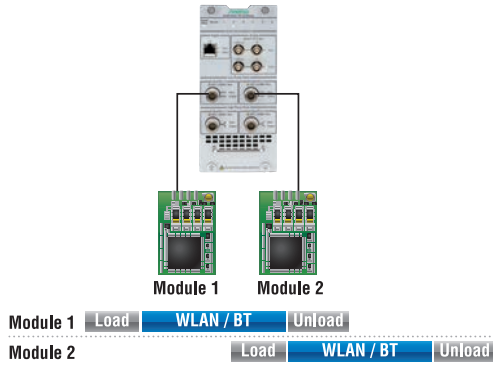

One TRX Test Module can be used to measure WLAN 802.11a/b/g/n/p, 11ac (Wave 2) and *Bluetooth* v4.2 modules.

Recommended Configuration

Model	Description	Qty.
MT8870A	Universal Wireless Test Set	1
MU88700xA	TRX Test Module	1
MU88700xA-001	6 GHz Frequency Extension	1
MX887030A	WLAN 802.11b/g/a/n TX Measurement	1
MX887031A	WLAN 802.11ac TX Measurement	1
MX887032A	WLAN 802.11p TX Measurement	1
MX887040A	<i>Bluetooth</i> TX Measurement	1
MX887040A-001	DLE TX Measurement	1
MV887030A	WLAN 802.11b/g/a/n Waveforms	1
MV887031A	WLAN 802.11ac Waveforms	1
MV887032A	WLAN 802.11p Waveforms	1
MV887040A	<i>Bluetooth</i> Waveforms	1
MV887040A-001	DLE Waveforms	1

WLAN 2x2 MIMO Module Measurement

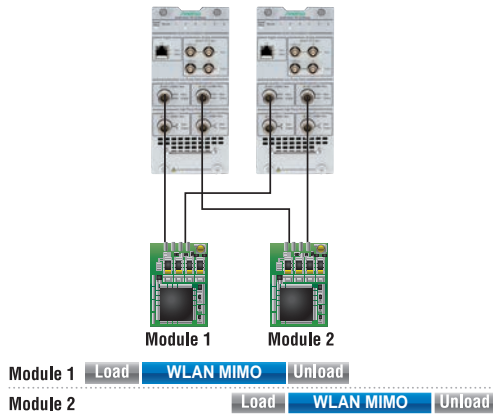

Using two TRX Test Modules supports True MIMO measurement of WLAN 802.11n and 11ac 2x2 MIMO modules.

Recommended Configuration

Model	Description	Qty.
MT8870A	Universal Wireless Test Set	1
MU88700xA	TRX Test Module	2
MU88700xA-001	6 GHz Frequency Extension	2
MX887030A	WLAN 802.11b/g/a/n TX Measurement	1
MX887031A	WLAN 802.11ac TX Measurement	1
MV887030A	WLAN 802.11b/g/a/n Waveforms	1
MV887031A	WLAN 802.11ac Waveforms	1

Universal Wireless Test Set MT8870A PC Applications

CombiView

CombiView is a PC application used to control the MT8870A and display graphical and numerical test results. It has the following functions:

Key Features

- Graphical display of TX measurement results using Windows interface
- Remote control of MT8870A (MU88700xA) via Ethernet and GPIB (option)
- Setting of MT8870A (MU88700xA)
- Signal generator interface for RX tests

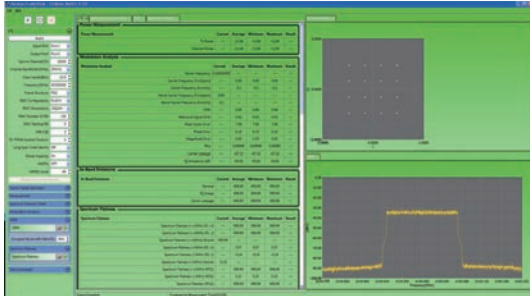

LTE FDD Uplink TX Measurement with Cellular Application Applet

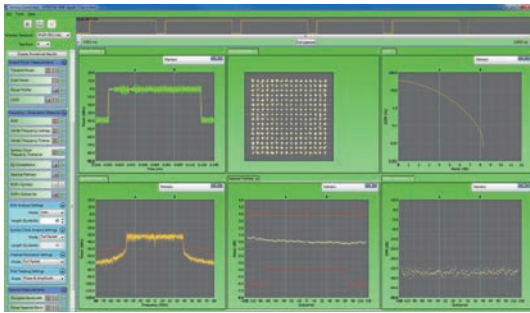

WLAN 802.11ac TX Measurement with SRW Application Applet

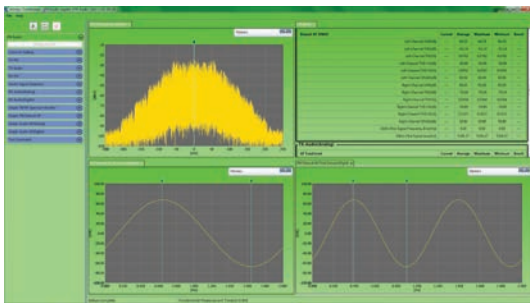

Audio Measurement with FM/Audio Application Applet

Utility Tool

The utility tool is a PC application used to detect the network and perform firmware updates.

Key Features

- Displays details of MT8870A and MU88700xA TRX Test Module(s) detected on network
- TRX Test Module MU88700xA firmware upgrade
- Waveform file transfer
- License registration

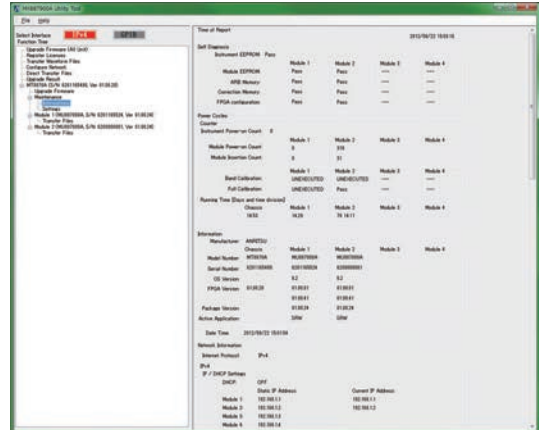

Universal Wireless Test Set MT8870A Specifications

Electrical Characteristics

Number of Slots	4
Internal Reference Oscillator	<p>Starting characteristics</p> <p>25°C, Referenced to frequency at 24-hour after power-on</p> <p>$\pm 5 \times 10^{-7}$ (2 minutes after power-on)</p> <p>$\pm 5 \times 10^{-8}$ (5 minutes after power-on)</p> <p>Aging rate: $\pm 1 \times 10^{-7}$/year</p> <p>Temperature characteristics: $\pm 2 \times 10^{-8}$ (+5° to +45°C)</p> <p>Initial calibration accuracy</p> <p>+20° to +30°C, 1 hour after power-on</p> <p>$\pm 2.2 \times 10^{-8}$</p>
Connector	<p>External reference input</p> <p>Connector: BNC-J (rear panel), 50Ω (nom.)</p> <p>Frequency: 10 MHz</p> <p>Operating range: ± 1 ppm</p> <p>Input level: -15 to +20 dBm, 50Ω (AC coupling)</p> <p>Reference signal output</p> <p>Connector: BNC-J (rear panel), 50Ω (nom.)</p> <p>Frequency: 10 MHz</p> <p>Output level: ≥ 0 dBm (AC coupling)</p> <p>Trigger</p> <p>Input/Output switching: Trigger input/output selectable</p> <p>Connector: BNC-J (rear panel, 4 ports)</p> <p>Input/Output level: TTL level</p> <p>Ethernet controller</p> <p>Control from external controller (excluding power-on/off)</p> <p>Ethernet (1000BASE-T)</p> <p>Connector: RJ-45 (front panel, rear panel)</p> <p>GPIB (with MT8870A-001)</p> <p>Connector: IEEE488 bus connector (rear panel, 4 ports)</p> <p>AUX</p> <p>Connector: 50-pin (correspond to DX10BM-50S, rear panel)</p>

General

Dimensions and Mass	<p>426 (W) × 221.5 (H) × 498 (D) mm (excluding projections)</p> <p>≤ 11.5 kg (excluding all options and test modules)</p> <p>≤ 30.0 kg (including options and test modules)</p>
Power Supply	<p>Power voltage: 100 V(ac) to 120 V(ac)/200 V(ac) to 240 V(ac)</p> <p>Frequency: 50 Hz/60 Hz</p> <p>Power consumption: ≤ 900 VA (including all options and test modules)</p>
Temperature Range	+5° to +45°C (operating), -20° to +60°C (storage)
EMC	EN61326-1, EN61000-3-2

TRX Test Module MU887000A Specifications

Input/Output Connector

RF Test Ports	<p>Number of ports 4</p> <p>Connector N(f)</p> <p>Impedance 50Ω (nom.)</p> <p>VSWR</p> <p>Test port 1 and 2</p> <ul style="list-style-type: none"> <1.5 (10 MHz ≤ f < 400 MHz) <1.2 (400 MHz ≤ f ≤ 2.7 GHz) <1.3 (2.7 GHz < f ≤ 3.8 GHz) <1.5 (3.8 GHz < f ≤ 6.0 GHz) <p>Test port 3 and 4</p> <ul style="list-style-type: none"> <1.8 (10 MHz ≤ f < 30 MHz) <1.5 (30 MHz ≤ f ≤ 3.8 GHz) <1.6 (3.8 GHz < f ≤ 6.0 GHz) <p>Maximum input level</p> <ul style="list-style-type: none"> +35 dBm (Test port 1 and 2) +25 dBm (Test port 3 and 4)
AF Test Ports	<p>Ports Analog port, Digital port</p> <p>Connector Analog port: BNC(f) Digital port: RJ-45</p>

Signal Generator

Frequency	<p>Setting range 10 MHz to 3.8 GHz 10 MHz to 6.0 GHz (with MU887000A-001)</p> <p>Resolution 1 Hz</p> <p>Accuracy Depends on MT8870A reference oscillator accuracy</p>
Amplitude	<p>Setting range</p> <p>Test port 1 and 2</p> <ul style="list-style-type: none"> -130 to -10 dBm (≤3.8 GHz) -130 to -18 dBm (>3.8 GHz) <p>Test port 3 and 4</p> <ul style="list-style-type: none"> -120 to 0 dBm (≤3.8 GHz) -120 to -8 dBm (>3.8 GHz) <p>Resolution 0.1 dB</p> <p>Accuracy CW, After CAL, 10° to 40°C</p> <p>Test port 1 and 2</p> <p>Output level: ≥-120 dBm (≤3.8 GHz), ≥-100 dBm (>3.8 GHz)</p> <ul style="list-style-type: none"> ±1.3 dB (10 MHz ≤ f < 400 MHz) (Signal Analyzer input level: +15 dBm) ±1.0 dB, ±0.7 dB (typ.) (400 MHz ≤ f ≤ 3.8 GHz) ±1.3 dB, ±1.0 dB (typ.) (3.8 GHz < f ≤ 6.0 GHz) <p>Test port 3 and 4</p> <p>Output level: ≥ -110 dBm</p> <ul style="list-style-type: none"> ±1.3 dB (10 MHz ≤ f < 400 MHz) ±1.0 dB, ±0.7 dB (typ.) (400 MHz ≤ f ≤ 3.8 GHz) ±1.3 dB, ±0.7 dB (typ.) (3.8 GHz < f ≤ 6.0 GHz)
Spurious Response	<p>Harmonic distortion <-25 dBc</p>
Vector Modulation	<p>Bandwidth 160 MHz (max.)</p>

Signal Analyzer

Frequency	<p>Setting range 10 MHz to 3.8 GHz 10 MHz to 6.0 GHz (with MU887000A-001)</p> <p>Resolution 1 Hz</p>
-----------	--

TRX Test Module MU887000A Specifications

Amplitude	<p>Setting range CW Test port 1 and 2 -65 to +15 dBm (10 MHz ≤ f < 350 MHz) -65 to +35 dBm (350 MHz ≤ f ≤ 6.0 GHz) Test port 3 and 4 -65 to +15 dBm (10 MHz ≤ f < 350 MHz) -65 to +25 dBm (350 MHz ≤ f ≤ 6.0 GHz)</p> <p>Resolution 0.1 dB</p> <p>Accuracy CW, After CAL, Measurement bandwidth: 300 kHz, RBW: 100 kHz Test port 1 and 2 10 MHz ≤ f < 400 MHz, Signal Generator: Off, +10° to +40°C ±0.7 dB (-30 dBm ≤ p ≤ +15 dBm) ±0.9 dB (-55 dBm ≤ p < -30 dBm) ±1.1 dB (-65 dBm ≤ p < -55 dBm) 400 MHz ≤ f ≤ 3.8 GHz, +10° to +40°C ±0.5 dB, ±0.3 dB (typ.) (-30 dBm ≤ p ≤ +35 dBm) ±0.7 dB (-55 dBm ≤ p < -30 dBm) ±0.9 dB (-65 dBm ≤ p < -55 dBm) 3.8 GHz < f ≤ 6.0 GHz, +20° to +30°C ±0.7 dB (-30 dBm ≤ p ≤ +35 dBm) ±0.9 dB (-55 dBm ≤ p < -30 dBm) ±1.1 dB (-65 dBm ≤ p < -55 dBm) Test port 3 and 4 10 MHz ≤ f < 400 MHz, +10° to +40°C ±0.7 dB (-30 dBm ≤ p ≤ +15 dBm) ±0.9 dB (-55 dBm ≤ p < -30 dBm) ±1.1 dB (-65 dBm ≤ p < -55 dBm) 400 MHz ≤ f ≤ 3.8 GHz, +10° to +40°C ±0.7 dB (-30 dBm ≤ p ≤ +25 dBm) ±0.9 dB (-55 dBm ≤ p < -30 dBm) ±1.1 dB (-65 dBm ≤ p < -55 dBm) 3.8 GHz < f ≤ 6.0 GHz, +20° to +30°C ±0.7 dB (-30 dBm ≤ p ≤ +25 dBm) ±0.9 dB (-55 dBm ≤ p < -30 dBm) ±1.1 dB (-65 dBm ≤ p < -55 dBm)</p> <p>Linearity CW, Measurement bandwidth: 300 kHz, RBW: 100 kHz ±0.2 dB (0 to -40 dB, ≥ -55 dBm) ±0.4 dB (0 to -40 dB, ≥ -65 dBm)</p>
Modulation Analysis	<p>Maximum bandwidth 25 MHz (10 MHz ≤ f < 500 MHz) 80 MHz (500 MHz ≤ f < 1.9 GHz) 160 MHz (1.9 GHz ≤ f ≤ 6.0 GHz)</p>

General

Interface	<p>Trigger Trigger signals input/output at trigger connectors (rear panel)</p> <p>Remote control Ethernet: via MT8870A interface GPIB: with MT8870A GPIB option (MT8870A-001) Interface function: SH1, AH1, T6, L4, SR1, RL1, PP0, DC1, DT0, C0, E2</p>
Dimensions and Mass	<p>90 (W) × 193.6 (H) × 325 (D) mm (excluding projections) ≤5 kg (including options)</p>

Audio Measurement Hardware MU887000A-002

Analog Audio	<p>Audio generator Frequency range: 20 Hz to 20 kHz Output level range: 0 (off), 1 mV to 5 V_{peak} (100 kΩ termination) Impedance: 1Ω (AC coupling) (nom.)</p> <p>Audio analyzer Frequency range: 20 Hz to 20 kHz Input level range: 1 mV peak to 5 V peak (30 V RMS, max.) Impedance: 100 kΩ (AC coupling)</p>
Digital Audio	<p>Audio generator Frequency range: 20 Hz to 20 kHz (Sampling rate: 44.1 kHz, 48 kHz) 20 Hz to 14 kHz (Sampling rate: 32 kHz) 20 Hz to 7 kHz (Sampling rate: 16 kHz)</p> <p>Bit resolution: 16 bits/24 bits</p> <p>Audio analyzer Sampling rate: 16, 32, 44.1, 48 kHz Bit resolution: 16 bits/24 bits</p>

TRX Test Module MU887001A Specifications

Input/Output Connector

RF Test Ports	<p>Number of ports 4</p> <p>Connector N(f)</p> <p>Impedance 50Ω (nom.)</p> <p>VSWR <1.5 (10 MHz ≤ f < 400 MHz) <1.2 (400 MHz ≤ f ≤ 2.7 GHz) <1.3 (2.7 GHz < f ≤ 3.8 GHz) <1.5 (3.8 GHz < f ≤ 6.0 GHz)</p> <p>Maximum input level +35 dBm</p>
AF Test Ports	<p>Ports Analog port, Digital port</p> <p>Connector Analog port: BNC(f) Digital port: RJ-45</p>

Signal Generator

Frequency	<p>Setting range 10 MHz to 3.8 GHz 10 MHz to 6.0 GHz (with MU887001A-001)</p> <p>Resolution 1 Hz</p> <p>Accuracy Depends on MT8870A reference oscillator accuracy</p>
Amplitude	<p>Setting range -130 to -10 dBm (≤3.8 GHz) -130 to -18 dBm (>3.8 GHz)</p> <p>Resolution 0.1 dB</p> <p>Accuracy CW, After CAL, 10° to 40°C Output level: ≥-120 dBm (≤3.8 GHz), ≥-100 dBm (>3.8 GHz) ±1.3 dB (10 MHz ≤ f < 400 MHz) (Signal Analyzer input level: +15 dBm) ±1.0 dB, ±0.7 dB (typ.) (400 MHz ≤ f ≤ 3.8 GHz) ±1.3 dB, ±1.0 dB (typ.) (3.8 GHz < f ≤ 6.0 GHz)</p>
Spurious Response	<p>Harmonic distortion <-25 dBc</p>
Vector Modulation	<p>Bandwidth 160 MHz (max.)</p>

TRX Test Module MU887001A Specifications

Signal Analyzer

Frequency	<p>Setting range 10 MHz to 3.8 GHz 10 MHz to 6.0 GHz (with MU887001A-001)</p> <p>Resolution 1 Hz</p>
Amplitude	<p>Setting range CW -65 to +15 dBm (10 MHz ≤ f < 350 MHz) -65 to +35 dBm (350 MHz ≤ f ≤ 6.0 GHz)</p> <p>Resolution 0.1 dB</p> <p>Accuracy CW, After CAL, Measurement bandwidth: 300 kHz, RBW: 100 kHz 10 MHz ≤ f < 400 MHz, Signal Generator: Off, +10° to +40°C ±0.7 dB (-30 dBm ≤ p ≤ +15 dBm) ±0.9 dB (-55 dBm ≤ p < -30 dBm) ±1.1 dB (-65 dBm ≤ p < -55 dBm) 400 MHz ≤ f ≤ 3.8 GHz, +10° to +40°C ±0.5 dB, ±0.3 dB (typ.) (-30 dBm ≤ p ≤ +35 dBm) ±0.7 dB (-55 dBm ≤ p < -30 dBm) ±0.9 dB (-65 dBm ≤ p < -55 dBm) 3.8 GHz < f ≤ 6.0 GHz, +20° to +30°C ±0.7 dB (-30 dBm ≤ p ≤ +35 dBm) ±0.9 dB (-55 dBm ≤ p < -30 dBm) ±1.1 dB (-65 dBm ≤ p < -55 dBm)</p> <p>Linearity CW, Measurement bandwidth: 300 kHz, RBW: 100 kHz ±0.2 dB (0 to -40 dB, ≥ -55 dBm) ±0.4 dB (0 to -40 dB, ≥ -65 dBm)</p>
Modulation Analysis	<p>Maximum bandwidth 25 MHz (10 MHz ≤ f < 500 MHz) 80 MHz (500 MHz ≤ f < 1.9 GHz) 160 MHz (1.9 GHz ≤ f ≤ 6.0 GHz)</p>

General

Interface	<p>Trigger Trigger signals input/output at trigger connectors (rear panel)</p> <p>Remote control Ethernet: via MT8870A interface GPIB: with MT8870A GPIB option (MT8870A-001) Interface function: SH1, AH1, T6, L4, SR1, RL1, PP0, DC1, DT0, C0, E2</p>
Dimensions and Mass	<p>90 (W) × 193.6 (H) × 325 (D) mm (excluding projections) ≤5 kg (including options)</p>

Audio Measurement Hardware MU887001A-002

Analog Audio	<p>Audio generator Frequency range: 20 Hz to 20 kHz Output level range: 0 (off), 1 mV to 5 V_{peak} (100 kΩ termination) Impedance: 1Ω (AC coupling) (nom.)</p> <p>Audio analyzer Frequency range: 20 Hz to 20 kHz Input level range: 1 mV peak to 5 V peak (30 V RMS, max.) Impedance: 100 kΩ (AC coupling)</p>
Digital Audio	<p>Audio generator Frequency range: 20 Hz to 20 kHz (Sampling rate: 44.1 kHz, 48 kHz) 20 Hz to 14 kHz (Sampling rate: 32 kHz) 20 Hz to 7 kHz (Sampling rate: 16 kHz)</p> <p>Bit resolution: 16 bits/24 bits</p> <p>Audio analyzer Sampling rate: 16, 32, 44.1, 48 kHz Bit resolution: 16 bits/24 bits</p>

Universal Wireless Test Set MT8870A Specifications Ordering Information

Please specify the model/order number, name and quantity when ordering.
The names listed in the chart below are Order Names. The actual name of the item may differ from the Order Name.

Model/Order No.	Name
MT8870A	Main frame Universal Wireless Test Set
B0666A	Standard accessories Power Cord: 1 pc Blank Panel: 3 pcs*1 DVD-R: 1 pc CombiView (DVD-R)
MX880050A	Cellular Application Applet (DVD-R)
MX880051A	SRW Application Applet (DVD-R)
MX880052A	FM/Audio Application Applet (DVD-R)
MX880053A	Signal Generator Application Applet (DVD-R)
MX880054A	Small Cell Application Applet (DVD-R)
MX880055A	IEEE 802.15.4 Application Applet (DVD-R)
MX880056A	MT8870A Utility Tool (DVD-R)
MX887900A	MT8870A Operation Manual (DVD-R)
W3605AE	MU887000A Operation Manual (DVD-R)
W3606AE	
MT8870A-001	Options GPIB Control
MT8870A-101	GPIB Control Retrofit
MT8870A-ES210	Warranty 2 Years Extended Warranty Service
MT8870A-ES310	3 Years Extended Warranty Service
MT8870A-ES510	5 Years Extended Warranty Service
B0666A	Application parts Blank Panel
B0664A	Rack Mount Kit (MT8870A)
B0665A	Carrying Case (MT8870A)
B0669A	Front Cover for 1MW5U (MT8870A)
J0006	GPIB Cable, 0.5 m
J0007	GPIB Cable, 1.0 m
J0008	GPIB Cable, 2.0 m
J0127A	Coaxial Cord, 1 m (BNC-P · RG-58A/U · BNC-P)
J0127B	Coaxial Cord, 2.0 m (BNC-P · RG-58A/U · BNC-P)
J0127C	Coaxial Cord, 0.5 m (BNC-P · RG-58A/U · BNC-P)
J0576B	Coaxial Cord, 1.0 m (N-P · 5D-2W · N-P)
J0576D	Coaxial Cord, 2.0 m (N-P · 5D-2W · N-P)
J0322A	Coaxial Cord, 0.5 m (SMA-P · SMA-P, DC to 18 GHz, 50Ω)
J0322B	Coaxial Cord, 1.0 m (SMA-P · SMA-P, DC to 18 GHz, 50Ω)
J0322C	Coaxial Cord, 1.5 m (SMA-P · SMA-P, DC to 18 GHz, 50Ω)
J0322D	Coaxial Cord, 2.0 m (SMA-P · SMA-P, DC to 18 GHz, 50Ω)
J0004	Coaxial Adapter (N-P · SMA-J)
J1261A	Ethernet Cable (Shield type, Straight, 1 m)
J1261B	Ethernet Cable (Shield type, Straight, 3 m)
J1261C	Ethernet Cable (Shield type, Crossover, 1 m)
J1261D	Ethernet Cable (Shield type, Crossover, 3 m)

*1: Installed in empty slots

Model/Order No.	Name
MN8116A	Application instruments Multi-Port Switch (16 ports)
MN8116A-001	16 Port Expansion Bank
MN8116A-101	16 Port Expansion Bank Retrofit
MN8116A-ES210	Warranty 2 Years Extended Warranty Service
MN8116A-ES310	3 Years Extended Warranty Service
MN8116A-ES510	5 Years Extended Warranty Service

Model/Order No.	Name
MU887000A	Test module TRX Test Module
MU887001A	TRX Test Module
W3606AE	Standard accessories DVD-R: 1 pc MU887000A Operation Manual (DVD-R)
MU887000A-001	Options 6 GHz Frequency Extension
MU887000A-101	6 GHz Frequency Extension Retrofit
MU887000A-002	Audio Measurement Hardware
MU887000A-102	Audio Measurement Hardware Retrofit
MU887001A-001	6 GHz Frequency Extension
MU887001A-101	6 GHz Frequency Extension Retrofit
MU887001A-002	Audio Measurement Hardware
MU887001A-102	Audio Measurement Hardware Retrofit
MU887000A-ES210	Warranty 2 Years Extended Warranty Service
MU887000A-ES310	3 Years Extended Warranty Service
MU887000A-ES510	5 Years Extended Warranty Service
MU887001A-ES210	2 Years Extended Warranty Service
MU887001A-ES310	3 Years Extended Warranty Service
MU887001A-ES510	5 Years Extended Warranty Service

Model/Order No.	Name
MX887010A	Measurement software Cellular Standards Sequence Measurement
MX887011A	W-CDMA/HSPA Uplink TX Measurement
MX887012A	GSM/EDGE Uplink TX Measurement
MX887013A	LTE FDD Uplink TX Measurement
MX887014A	LTE TDD Uplink TX Measurement
MX887015A	CDMA2000 Reverse Link TX Measurement
MX887016A	1xEV-DO Reverse Link TX Measurement
MX887017A	TD-SCDMA Uplink TX Measurement
MX887021A	W-CDMA/HSPA Downlink TX Measurement
MX887023A	LTE FDD Downlink TX Measurement
MX887030A	WLAN 802.11b/g/a/n TX Measurement*2
MX887031A	WLAN 802.11ac TX Measurement*2
MX887032A	WLAN 802.11p TX Measurement*2
MX887040A	Bluetooth TX Measurement
MX887040A-001	DLE TX Measurement
MX887050A	Short Range Wireless Average Power and Frequency Measurement
MX887060A	IEEE 802.15.4 TX Measurement
MX887061A	Z-Wave TX Measurement
MX887070A	FM/Audio TRX Measurement*3
MX887090A	Multi-DUT Measurement Scheduler

Model/Order No.	Name
	Waveforms
MV887011A	W-CDMA/HSPA Downlink Waveforms
MV887012A	GSM/EDGE Downlink Waveforms
MV887013A	LTE FDD Downlink Waveforms
MV887014A	LTE TDD Downlink Waveforms
MV887015A	CDMA2000 Forward Link Waveforms
MV887016A	1xEV-DO Forward Link Waveforms
MV887017A	TD-SCDMA Downlink Waveforms
MV887021A	W-CDMA/HSPA Uplink Waveforms
MV887023A	LTE FDD Uplink Waveforms
MV887030A	WLAN 802.11b/g/a/n Waveforms*2
MV887031A	WLAN 802.11ac Waveforms*2
MV887032A	WLAN 802.11p Waveforms

Model/Order No.	Name
MV887040A	Bluetooth Waveforms
MV887040A-001	DLE Waveforms
MV887060A	IEEE 802.15.4 Waveforms
MV887061A	Z-Wave Waveforms
MV887070A	FM RDS Waveforms
MV887100A	GPS Waveforms
MV887101A	Galileo Waveforms
MV887102A	GLONASS Waveforms
MV887103A	BeiDou Waveforms
MV887110A	DVB-H Waveforms
MV887111A	ISDB-T Waveforms
MV887112A	ISDB-Tmm Waveforms

*2: Requires MU88700xA-001 for 5 GHz (802.11a/n/p/ac) frequency measurements
 *3: Requires MU88700xA-002 for audio signal measurements

CDMA2000® is a registered trademark of the Telecommunications Industry Association (TIA-USA).
 The *Bluetooth*® mark and logos are owned by Bluetooth SIG, Inc. and are used by Anritsu under license.
 Windows® is a registered trademark of Microsoft Corporation in the USA and other countries.
 Other companies, product names and service names are registered trademarks of their respective companies.



Specifications are subject to change without notice.

• **United States**

Anritsu Company

1155 East Collins Blvd., Suite 100, Richardson,
 TX 75081, U.S.A.
 Toll Free: 1-800-267-4878
 Phone: +1-972-644-1777
 Fax: +1-972-671-1877

• **Canada**

Anritsu Electronics Ltd.

700 Silver Seven Road, Suite 120, Kanata,
 Ontario K2V 1C3, Canada
 Phone: +1-613-591-2003
 Fax: +1-613-591-1006

• **Brazil**

Anritsu Eletrônica Ltda.

Praça Amadeu Amaral, 27 - 1 Andar
 01327-010 - Bela Vista - São Paulo - SP - Brazil
 Phone: +55-11-3283-2511
 Fax: +55-11-3288-6940

• **Mexico**

Anritsu Company, S.A. de C.V.

Av. Ejército Nacional No. 579 Piso 9, Col. Granada
 11520 México, D.F., México
 Phone: +52-55-1101-2370
 Fax: +52-55-5254-3147

• **United Kingdom**

Anritsu EMEA Ltd.

200 Capability Green, Luton, Bedfordshire, LU1 3LU, U.K.
 Phone: +44-1582-433200
 Fax: +44-1582-731303

• **France**

Anritsu S.A.

12 avenue du Québec, Bâtiment Iris 1- Sillic 612,
 91140 VILLEBON SUR YVETTE, France
 Phone: +33-1-60-92-15-50
 Fax: +33-1-64-46-10-65

• **Germany**

Anritsu GmbH

Nemetschek Haus, Konrad-Zuse-Platz 1
 81829 München, Germany
 Phone: +49-89-442308-0
 Fax: +49-89-442308-55

• **Italy**

Anritsu S.r.l.

Via Elio Vittorini 129, 00144 Roma, Italy
 Phone: +39-6-509-9711
 Fax: +39-6-502-2425

• **Sweden**

Anritsu AB

Kistagången 20B, 164 40 KISTA, Sweden
 Phone: +46-8-534-707-00
 Fax: +46-8-534-707-30

• **Finland**

Anritsu AB

Teknobulevardi 3-5, FI-01530 VANTAA, Finland
 Phone: +358-20-741-8100
 Fax: +358-20-741-8111

• **Denmark**

Anritsu A/S

Kay Fiskers Plads 9, 2300 Copenhagen S, Denmark
 Phone: +45-7211-2200
 Fax: +45-7211-2210

• **Russia**

Anritsu EMEA Ltd.

Representation Office in Russia
 Tverskaya str. 16/2, bld. 1, 7th floor.
 Moscow, 125009, Russia
 Phone: +7-495-363-1694
 Fax: +7-495-935-8962

• **Spain**

Anritsu EMEA Ltd.

Representation Office in Spain
 Edificio Cuzco IV, Po. de la Castellana, 141, Pta. 8
 28046, Madrid, Spain
 Phone: +34-915-726-761
 Fax: +34-915-726-621

• **United Arab Emirates**

Anritsu EMEA Ltd.

Dubai Liaison Office
 P O Box 500413 - Dubai Internet City
 Al Thuraya Building, Tower 1, Suit 701, 7th Floor
 Dubai, United Arab Emirates
 Phone: +971-4-3670352
 Fax: +971-4-3688460

• **India**

Anritsu India Private Limited

2nd & 3rd Floor, #837/1, Binnamangla 1st Stage,
 Indiranagar, 100ft Road, Bangalore - 560038, India
 Phone: +91-80-4058-1300
 Fax: +91-80-4058-1301

• **Singapore**

Anritsu Pte. Ltd.

11 Chang Charn Road, #04-01, Shriro House
 Singapore 159640
 Phone: +65-6282-2400
 Fax: +65-6282-2533

• **P.R. China (Shanghai)**

Anritsu (China) Co., Ltd.

Room 2701-2705, Tower A,
 New Caohejing International Business Center
 No. 391 Gui Ping Road Shanghai, 200233, P.R. China
 Phone: +86-21-6237-0898
 Fax: +86-21-6237-0899

• **P.R. China (Hong Kong)**

Anritsu Company Ltd.

Unit 1006-7, 10/F., Greenfield Tower, Concordia Plaza,
 No. 1 Science Museum Road, Tsim Sha Tsui East,
 Kowloon, Hong Kong, P.R. China
 Phone: +852-2301-4980
 Fax: +852-2301-3545

• **Japan**

Anritsu Corporation

8-5, Tamura-cho, Atsugi-shi, Kanagawa, 243-0016 Japan
 Phone: +81-46-296-6509
 Fax: +81-46-225-8359

• **Korea**

Anritsu Corporation, Ltd.

5FL, 235 Pangyoeyeok-ro, Bundang-gu, Seongnam-si,
 Gyeonggi-do, 463-400 Korea
 Phone: +82-31-696-7750
 Fax: +82-31-696-7751

• **Australia**

Anritsu Pty. Ltd.

Unit 20, 21-35 Ricketts Road,
 Mount Waverley, Victoria 3149, Australia
 Phone: +61-3-9558-8177
 Fax: +61-3-9558-8255

• **Taiwan**

Anritsu Company Inc.

7F, No. 316, Sec. 1, NeiHu Rd., Taipei 114, Taiwan
 Phone: +886-2-8751-1816
 Fax: +886-2-8751-1817